

Multilin 469

Complete integrated protection and management of medium and large motors

The Multilin™ 469 Motor Protection System, a member of the SR family of relays, provides protection, control, simplified configuration and advanced communications in a cost effective industry leading draw-out construction. Designed for medium voltage motors, the 469 delivers advanced protection with customizable overload curves and single CT differential protection for added flexibility. The 469 also provides simplified configuration using the Motor Settings Auto-Configurator, providing a quick and easy set-up of motor parameters. Coupled with advanced protection and diagnostics, the 469 provides users the flexibility of multiple communication protocols allowing integration into new and existing control networks.

Key Benefits

- Comprehensive motor protection plus voltage dependant overload curves, torque metering and protection, broken rotor bar protection
- Most advanced thermal model - Including multiple RTD inputs for stator thermal protection
- Minimize replacement time - Draw-out construction
- Complete asset monitoring - Temperature, Analog I/O, full metering including demand & energy
- Improve uptime of auxiliary equipment - Through I/O monitoring
- Reduce troubleshooting time and maintenance costs - Event reports, waveform capture, data logger
- Built in simulation functions simplify testing and commissioning
- Cost Effective Access to information - Through standard RS232 & RS485 serial ports, and optional Ethernet and DeviceNet Ports
- Field upgradable firmware and settings
- Optional Conformal coating for exposure to chemically corrosive or humid environments

Applications

- Protection and Management of three phase medium and large horsepower motors and driven equipment, including high inertia, two speed and reduced-voltage start motors



Protection and Control

- Thermal model biased with RTD and negative sequence current feedback
- Start supervision and inhibit
- Mechanical jam
- Voltage compensated acceleration
- Undervoltage, overvoltage
- Underfrequency
- Stator differential protection
- Thermal overload
- Overtemperature protection
- Phase and ground overcurrent
- Current unbalance
- Power elements
- Torque protection
- Dual overload curves for 2 speed motors
- Reduced voltage starting control

Communications

- Multiple Ports - 10baseT Ethernet, RS485, RS232, RS422, DeviceNet
- Multiple Protocols - Modbus RTU, Modbus TCP/IP, DeviceNet

Monitoring & Metering

- A, V, W, var, VA, PF, Hz, Wh, varh, demand
- Torque, temperature (12 RTDs)
- Event recorder
- Oscillography & Data Logger (trending)
- Statistical information & learned motor data

EnerVista Software

- State of the art software for configuration and commissioning Multilin products
- Document and software archiving toolset to ensure reference material and device utilities are up-to-date
- EnerVista™ Integrator providing easy integration of data in the 469 into new or existing monitoring and control systems



Protection and Control

The 469 is a digital motor protection system designed to protect and manage medium and large motors and driven equipment. It contains a full range of selectively enabled, self contained protection and control elements as detailed in the Functional Block Diagram and Features table.

Motor Thermal Model

The primary protective function of the 469 is the thermal model with six key elements:

- Overload Curves
- Unbalance Biasing
- Hot/Cold Safe Stall Ratio
- Motor Cooling Time Constants
- Start Inhibit and Emergency Restart
- RTD Biasing

Overload Curves

The curves can take one of three formats: standard, custom, or voltage dependent. For all curve styles, the 469 retains thermal memory in a thermal capacity used register which is updated every 0.1 second. The overload pickup determines where the running overload curve begins.

The 469 standard overload curves are of standard shape with a multiplier value of 1 to 15.

The voltage dependent overload curves are used in high inertia load applications, where motor acceleration time can actually exceed the safe stall time and motor thermal limits. During motor acceleration, the programmed thermal overload curve is dynamically adjusted with reference to the system voltage level. The selection of the overload curve type and the shape is based on motor thermal limit curves provided by motor vendor.

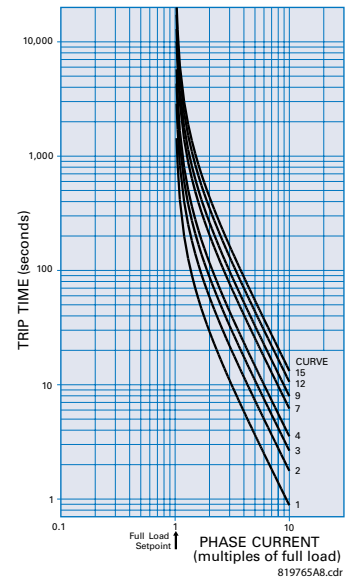

Fifteen standard overload curves.

Functional Block Diagram

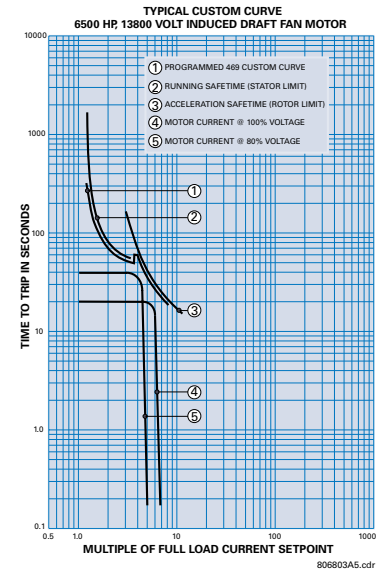
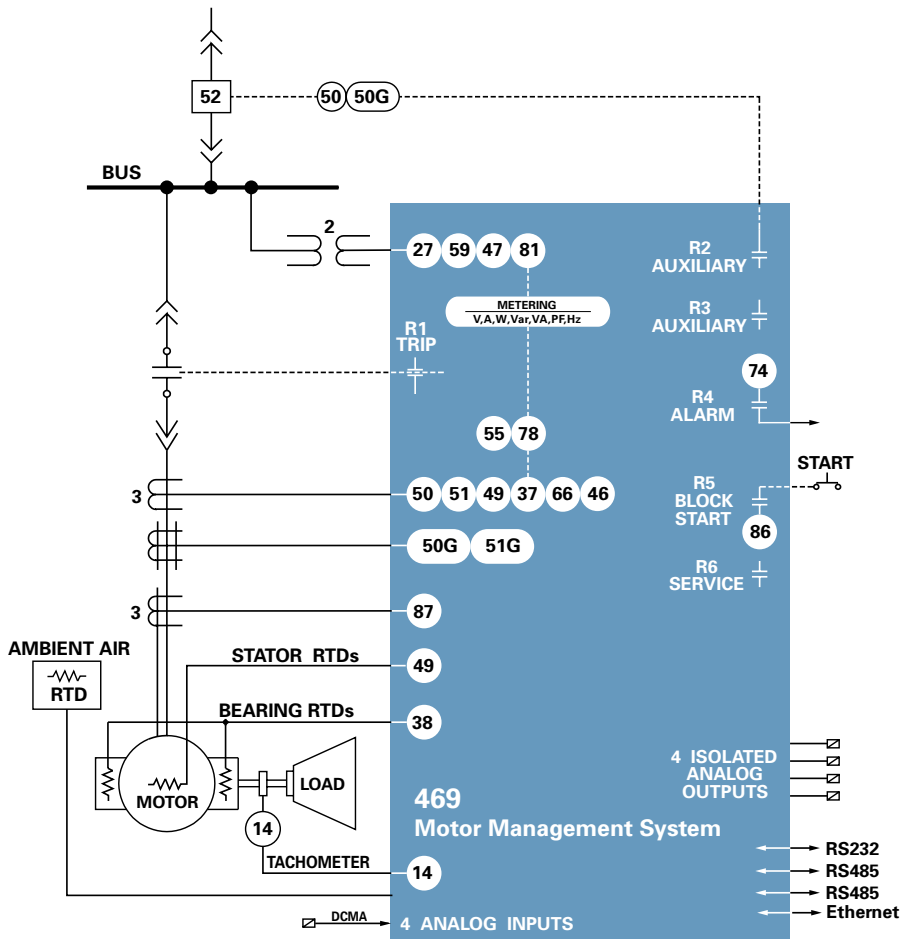

Typical custom overload curve.

Device Number	Function
14	Speed switch
19/48	Reduced voltage start and incomplete sequence
27/59	Undervoltage/Overvoltage
32	Reverse power
	Mechanical Jam
	Acceleration time
	Over Torque
37	Undercurrent/Underpower
38	Bearing RTD
46	Current Unbalance
47	Phase Reversal
49	Stator RTD
50	Short circuit backup
50G/51G	Ground overcurrent backup
51	Overload
55	Power factor
66	Starts/hour and time between starts
81	Frequency
86	Overload lockout
87	Differential

Unbalance (Negative Sequence Current) Biasing

Negative sequence current, which causes rotor heating, is not accounted for in the thermal limit curves supplied by the motor manufacturer. The 469 measures unbalance as the ratio of negative to positive sequence current. The thermal model is biased to reflect the additional heating. Motor derating due to current unbalance can be selected via the setpoint unbalance bias k factor. Unbalance voltage causes approximately 6 times higher level of current unbalance (1% of voltage unbalance equal to 6% of current unbalance). Note that the k=8 curve is almost identical to the NEMA derating curve.

Hot/Cold Safe Stall Ratio

The Hot/Cold Safe Stall time ratio defines the steady state level of thermal capacity used (TCU) by the motor. This level corresponds to normal operating temperature of the fully loaded motor and will be adjusted proportionally if motor load is lower than rated.

The Hot/Cold Safe Stall ratio is used by the relay to determine the lower limit of the running cool down curve, and also defines the thermal capacity level of the central point in RTD Biasing curve.

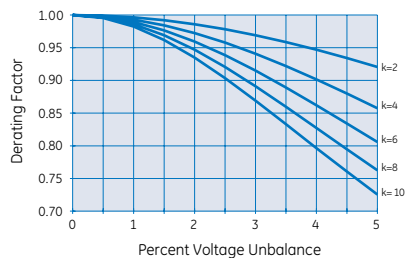

Motor derating factor due to unbalanced voltage

Motor Cooling Time Constants

When the 469 detects that the motor is running at a load lower than overload pickup setpoint, or the motor is stopped, it will start reducing the stored TCU value, simulating actual motor cool down process. TCU decays exponentially at a rate dictated by Cooling Time Constants setpoints. Normally the cooling down process of the stopped motor is much slower than that of a running motor, thus running and stopped cooling time constants setpoints are provided in the relay to reflect the difference.

The TCU lower limit of the running cool down curve is defined by Hot/Cold Safe Stall Ratio and level of the motor load. The TCU lower limit of the stopped cool down curve is 0% and corresponds to motor at ambient temperature.

Start Inhibit and Emergency Restart

The Start Inhibit function prevents starting of

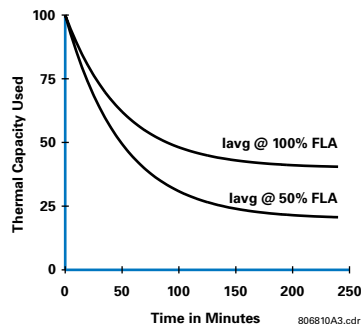

Exponential cooldown (hot/cold curve ratio 60%)

a motor when insufficient thermal capacity is available or motor start supervision function dictate the start inhibit. In case of emergency the thermal capacity used and motor start supervision timers can be reset to allow the hot motor starting.

RTD Biasing

The 469 thermal overload curves are based solely on measured current, assuming a normal 40°C ambient and normal motor cooling. The actual motor temperature will increase due to unusually high ambient temperature, or motor cooling blockage. Use the RTD bias feature to augment the thermal model calculation of Thermal Capacity Used, if the motor stator has embedded RTDs.

The RTD bias feature is feedback of measured stator temperature. This feedback acts to correct the assumed thermal model. Since RTDs have a relatively slow response, RTD biasing is useful for slow motor heating. Other portions of the thermal model are required during starting and heavy overload conditions when motor heating is relatively fast.

For RTD temperatures below the RTD BIAS MINIMUM setting, no biasing occurs. For maximum stator RTD temperatures above the RTD BIAS MAXIMUM setting, the thermal memory is fully biased and forced to 100%. At values in between, if the RTD bias thermal capacity used is higher compared to the thermal capacity used created by other features of the thermal model, then this value is used from that point onward.

Motor Start Supervision

Motor Start Supervision consists of the following features: Time-Between-Starts, Start-per-Hour, Restart Time.

These elements are intended to guard the motor against excessive starting duty, which is normally defined by the motor manufacturer in addition to the thermal damage curves.

Mechanical Jam and Acceleration Time

These two elements are used to prevent motor damage during abnormal operational conditions such as excessively long acceleration times or stalled rotor.

Phase Differential Protection

This function is intended to protect the stator windings and supply power cables of large motors. Two types of current transformers connections are supported:

- 6 CT's externally connected in the summing configuration.
- 3 Flux Balancing CT's.

Separate trip pickup levels and time delays are provided for motor starting and running conditions.

Short Circuit Trip

This function is intended to protect the stator windings of the motors against phase-to-phase faults.

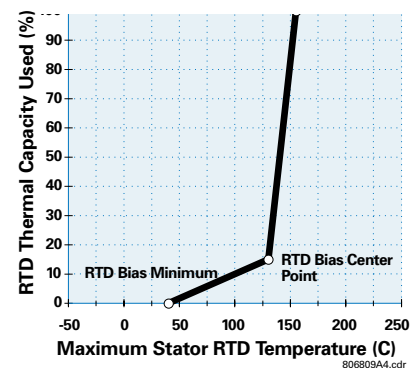

RTD Bias curve.

Equipped with an overreach filter, the 469 removes the DC component from the asymmetrical current present at the moment a fault occurs or motor starts.

A trip backup feature is also available as part of this function, used to issue a second trip if the fault is not cleared within a given time delay.

The backup feature can also be assigned to an auxiliary contact for annunciation or remote tripping of upstream protection devices

Ground Fault

This function is designed to protect motors against phase to ground faults.

There are two dedicated ground current inputs in the relay, which support the following types of ground current detection.

- Core balance (Zero sequence) current transformer.
- Core balance (Zero sequence) 50:0.025 A (sensitive) current transformer.
- Residual connection of phase current transformers.

The function is equipped with an overreach filter, which removes the DC component from the asymmetrical current present at the moment a fault occurs, or a motor starts. Two pickup levels (trip and alarm) with individual time delays are available for ground fault detection.

A trip Backup feature is also available as part of this function. The operational principle of Ground Fault Trip Backup is the same as of Short Circuit Trip Backup.

Voltage and Frequency Protection

Use the voltage and frequency protection functions to detect abnormal system voltage and frequency conditions, potentially hazardous to the motor.

The following voltage elements are available:

- Over and Undervoltage
- Over and Underfrequency
- Phase Reversal

To avoid nuisance trips, the 469 can be set to block the undervoltage element when the bus that supplies power to the motor is de-energized, or under VT fuse failure conditions.

Power Elements

The following power elements are available in 469 relay. The first four elements have blocking provision during motor starting.

Power Factor

This element is used in synchronous motors applications to detect out-of-synchronism conditions.

Reactive Power

This element is used in applications where the reactive power limit is specified.

Underpower

Used to detect loss of load.

Reverse Active Power

Useful to detect conditions where the motor can become a generator.

Overtorque

This element is used to protect the driven load from mechanical breakage.

Current Unbalance

In addition to thermal model biasing current unbalance is available in the 469 relay as an independent element with 2 pickup levels and a built-in single phasing detection algorithm.

RTD Protection

The 469 has 12 programmable RTD inputs supporting 4 different types of RTD sensors. RTD inputs are normally used for monitoring stator, bearings, ambient temperature as well as other parts of the motor assembly that can be exposed to overheating. Each RTD input has 3 operational levels: alarm, high alarm and trip. The 469 also supports RTD trip voting and provides open/short RTD failure alarms.

Additional and Special Features

- Two speed motor protection.
- Load averaging filter for cyclic load applications
- Reduced voltage starting supervision.
- Variable frequency filter allowing accurate sensing and calculation of the analog values in VFD applications.
- Analog input differential calculation for dual drives applications.
- Speed counter trip and alarm.
- Universal digital counter trip and alarm.
- Pulsing KWh and Kvarh output.
- Trip coil supervision.
- Drawout indicator, Setpoints Access and Test permit inputs.
- Undervoltage Autorestart (Optional)
- Broken rotor bar detection system (Optional)
- VT Fuse Failure

Inputs and Outputs

Current and Voltage Inputs

The 469 has two sets of three phase CT inputs, one for phase current, and one dedicated for differential protection.

The ratings of the phase current inputs (1A and 5A) must be specified when ordering the relay, while the ratings for differential inputs are field programmable, supporting both 1A and 5A secondary currents.

There are also 2 single-phase ground CT inputs: A standard input with settable secondary rating; 5A or 1A, and a high sensitivity ground current detection input for high resistance grounded systems.

Three phase VT inputs support delta and wye configuration and provide voltage signals for all voltage, frequency and power based protection elements and metering.

Digital Inputs

The 469 has 5 predefined inputs:

- Starter Status
- Emergency Restart
- Remote Reset
- Setpoint Access
- Test Switch

The 469 also has four assignable digital inputs, which can be configured as the following functions:

- Remote Trip and Alarm
- Speed Switch Trip and Tachometer
- Vibration Switch Trip and Alarm
- Pressure Switch Trip and Alarm
- Load Shed Trip
- Universal Digital Counter
- External oscillography trigger and External Relay Fault Simulation initiation
- General Switch with programmable functions and outputs

Analog Inputs and Outputs

Use the four configurable analog inputs available in the 469 to measure motor operation related quantities fed to the relay from standard transducers. Each input can be individually set to measure 4-20 mA, 0-20 mA or 0-1 mA transducer signals. The 469 can also

be set to issue trip or alarm commands based on signal thresholds.

Use the four configurable analog outputs available in the 469 to provide standard transducer signals to local monitoring equipment. The desired output signal must be specified when the relay is ordered, either 4-20 mA, or 0-1 mA. The analog outputs can be configured to provide outputs based on any measured analog value, or any calculated quantity.

Output Relays

There are six Form-C output relays available in the 469. Four relays are always non-failsafe and can be selectively assigned to perform trip, or alarm functions. A non-failsafe block start relay is also provided, controlled by protection functions requiring blocking functionality. Loss of control power or 469 internal failures are indicated via the failsafe service relay. The trip and alarm relays can also be configured with latching functionality.

Monitoring and Metering

The 469 includes high accuracy metering and recording for all AC signals. Voltage, current, RTD and power metering are built into the relay as a standard feature.

Metering

The following system values are accurately metered and displayed:

- Phase, differential and ground currents, average current, motor load, current unbalance.
- Phase-to-ground and Phase-to-phase voltages, average phase voltage, system frequency.
- Real, reactive, apparent power, power factor, wathours, varhours, torque
- Current and power demand.
- Analog inputs and RTD temperatures.
- Thermal capacity used, lockout times, motor speed

Monitoring

The 469 is equipped with monitoring tools to capture data. The following information is presented in a suitable format.

- Status of inputs, outputs and alarms
- Last trip data
- Motor learned parameters: last and maximum acceleration times, starting currents and starting TCU, average currents, RTD maximums, analog inputs maximums and minimums.
- Trip and general counters, motor running hours and start timers.
- Event recorder
- Oscillography

User Interface

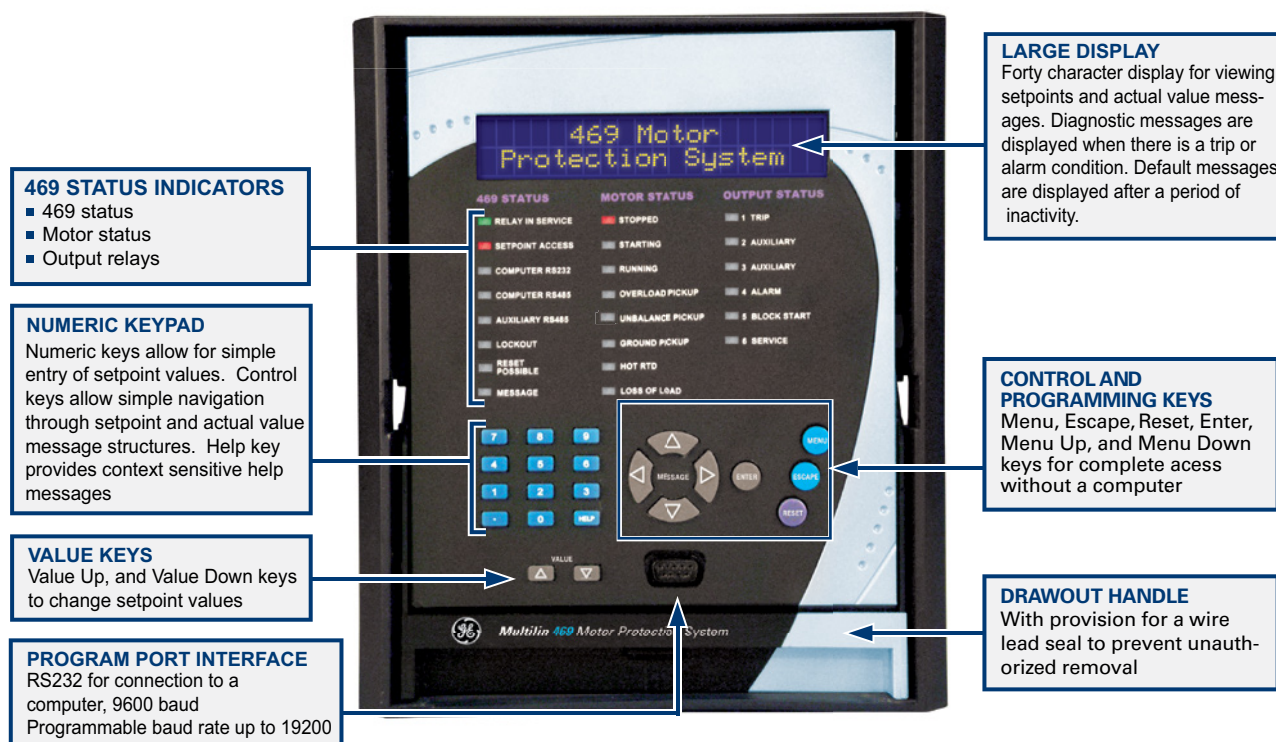

Event Recorder

The event recorder stores motor and system information with a date and time stamp each time a system event occurs. Up to 256 events are recorded.

Oscillography

The 469 records up to 64 cycles with 12 samples per cycle of waveform data for 10 waveforms (Ia, Ib, Ic, Ig, Diffa, Diffb, Diffc, Va, Vb, Vc) each time a trip occurs. The record is date and time stamped.

Advanced Motor Diagnostics

The Multilin M60 provides advanced motor diagnostics including a broken rotor bar detection function. The broken rotor bar detection is a condition maintenance function that continuously monitors the motor's health while in operation. The advanced Motor Current Signature Analysis (MCSA) continuously analyzes the motor current signature and based on preset algorithms will determine when a broken rotor bar is present in the motor.

With fully programmable alarms, the broken rotor bar function will provide early detection of any rotor problems and advise maintenance personnel of the impending issue allowing for predictive maintenance of the motor and prevention of catastrophic motor failures.

By providing early indication of potential rotor problems, serious system issues such as: reduced starting torque, overloads, torque and speed oscillation and bearing wear can be avoided. With the advanced broken rotor bar detection system, advanced warning of impending problems reduces catastrophic failures, maximizing motor life and system uptime.

Simulation

The simulation feature tests the functionality and relay response to programmed conditions without the need for external inputs. When placed in simulation mode the 469 suspends reading of the actual inputs and substitutes them with the simulated values. Pre-trip and fault conditions can be simulated, with currents, voltages, system frequency, RTD temperatures, and analog inputs configured for each state.

User Interfaces

Keypad and Display

The 469 has a keypad and 40 character display for local monitoring and relay configuration without the need for a computer. Up to 20 user-selected default messages can be displayed when inactive. In the event of a trip, alarm, or start block, the display will automatically default to the pertinent message and the Message LED indicator will flash.

LED Indicators

The 469 has 22 LED indicators on the front panel. These give a quick indication of 469 status, motor status, and output relay status.

Communications

The 469 is equipped with three standard serial communications ports, one RS232 located in the front panel for easy troubleshooting and programming, and two RS485 in the rear of the relay. Optional 10BaseT Ethernet and DeviceNet ports are also available. The rear RS485 ports provide remote communications or connection to a DCS, SCADA, or PLC. The RS232 and RS485 ports support user programmable baud rates from 300 to 19,200 bps. The optional Ethernet port can be used to connect the 469 to 10 Mbps Ethernet networks. The three serial ports support ModBus® RTU protocol, while the Ethernet port supports ModBus® RTU via TCP/IP protocol. The communication system of the 469 is designed to allow simultaneous communication via all ports.

Using Ethernet as the physical media to integrate the 469 to Local or Wide Area Networks, replaces a multidrop-wired network (e.g., serial Modbus®), and eliminates expensive leased or dial-up connections, reducing monthly operating costs.

EnerVista Software

The EnerVista Suite is an industry leading set of software programs that will simplify every aspect of using the 469 relay. Tools to monitor the status of your motor, maintain your relay, and integrate information measured by the 469 into HMI or SCADA monitoring systems are available. Also provided are the utilities to analyze the cause of faults and system disturbances using the powerful Waveform and Sequence of Event viewers that come with the 469 Setup Software that is included with each relay.

Viewpoint Maintenance

Viewpoint Maintenance provides tools that will increase the security of your 469, create reports on the operating status of the relay, and simplify the steps to troubleshoot protected generators. Tools available in Viewpoint Maintenance include:

- Settings Audit Trail Report
- Device Health Report
- Comprehensive Fault Diagnostics

Viewpoint Monitoring

Viewpoint Monitoring is a powerful yet simple-to-use monitoring and data recording of small systems. Viewpoint Monitoring provides a complete HMI package with the following functionality:

- Plug-&-Play Device Monitoring
- Single-Line Monitoring & Control
- Annunciator Alarming
- Trending Reports
- Automatic Event Retrieval
- Automatic Waveform Retrieval

EnerVista Integrator

EnerVista Integrator is a toolkit that allows seamless integration of Multilin devices into new or existing automation systems. Included in EnerVista Integrator is:

- OPC/DDE Server
- Multilin Drivers
- Automatic Event Retrieval
- Automatic Waveform Retrieval

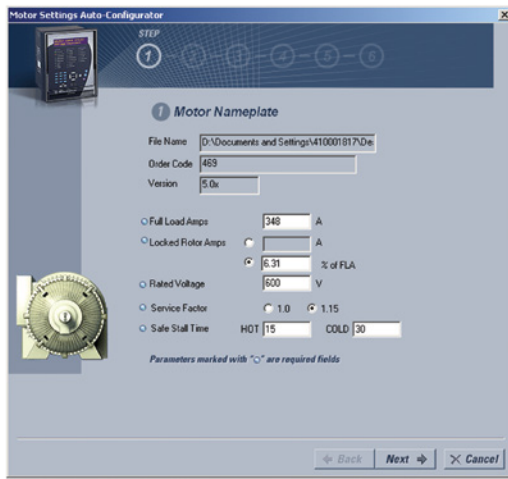
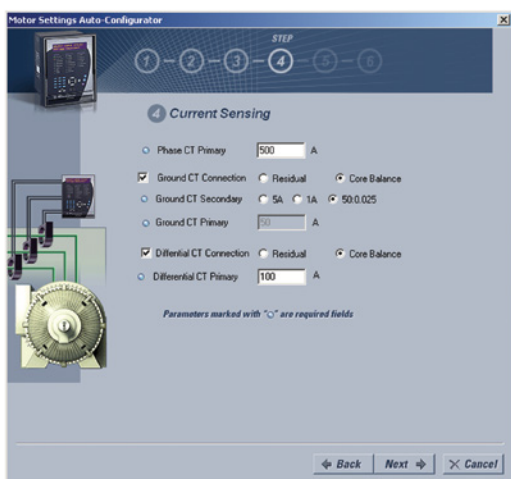

Create complete settings files for your 469 in 6 simple steps using the Motor Settings Auto-Configurator.

Retrofit Existing Multilin SR 469 Devices in Minutes

Traditionally, retrofitting or upgrading an existing relay has been a challenging and time consuming task often requiring re-engineering, panel modifications, and re-wiring. The Multilin 8 Series Retrofit Kit provides a quick, 3-step solution to upgrade previously installed Multilin SR 469 protection relays, reducing upgrade costs.

With the new 8 Series Retrofit Kit, users are able to install a new 869 Motor Protection System without modifying existing panel or switchgear cutouts, re-wiring, or need for drawing changes and re-engineering time and cost.

With this three-step process, operators are able to upgrade existing SR relays in as fast as 21 minutes, simplifying maintenance procedures and reducing system downtime.

1

Update Settings File

EnerVista 8 Series Setup Software provides automated setting file conversion with graphical report to quickly and easily verify settings and identify any specific settings that may need attention.

2

Replace Relay

Simply remove the upper, lower and low voltage terminal blocks and then remove the SR chassis from the panel. No need to disconnect any of the field wiring.

3

Plug & Play Reconnection

Insert the new 8 Series Retrofit chassis into the switchgear and simply plug-in the old terminal blocks - there is need to make any cut-out modifications or push and pull cables.

The 8 Series Retrofit Kit comes factory assembled and tested as a complete unit with the 8 Series protection device and includes replacement hardware (terminal blocks and screws) if the existing hardware is significantly aged or damaged.

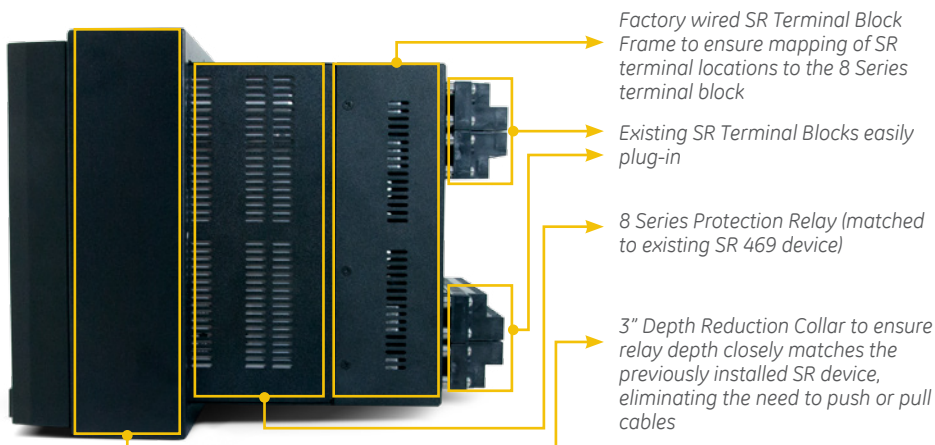

Explore in Detail

Visit us online to explore the SR to 8 Series retrofit kit in detail using our interactive app. www.GEGridSolutions.com/8SeriesRetrofitKit



Multilin 8 Series Retrofit: Solutions Explorer Application

Typical Wiring

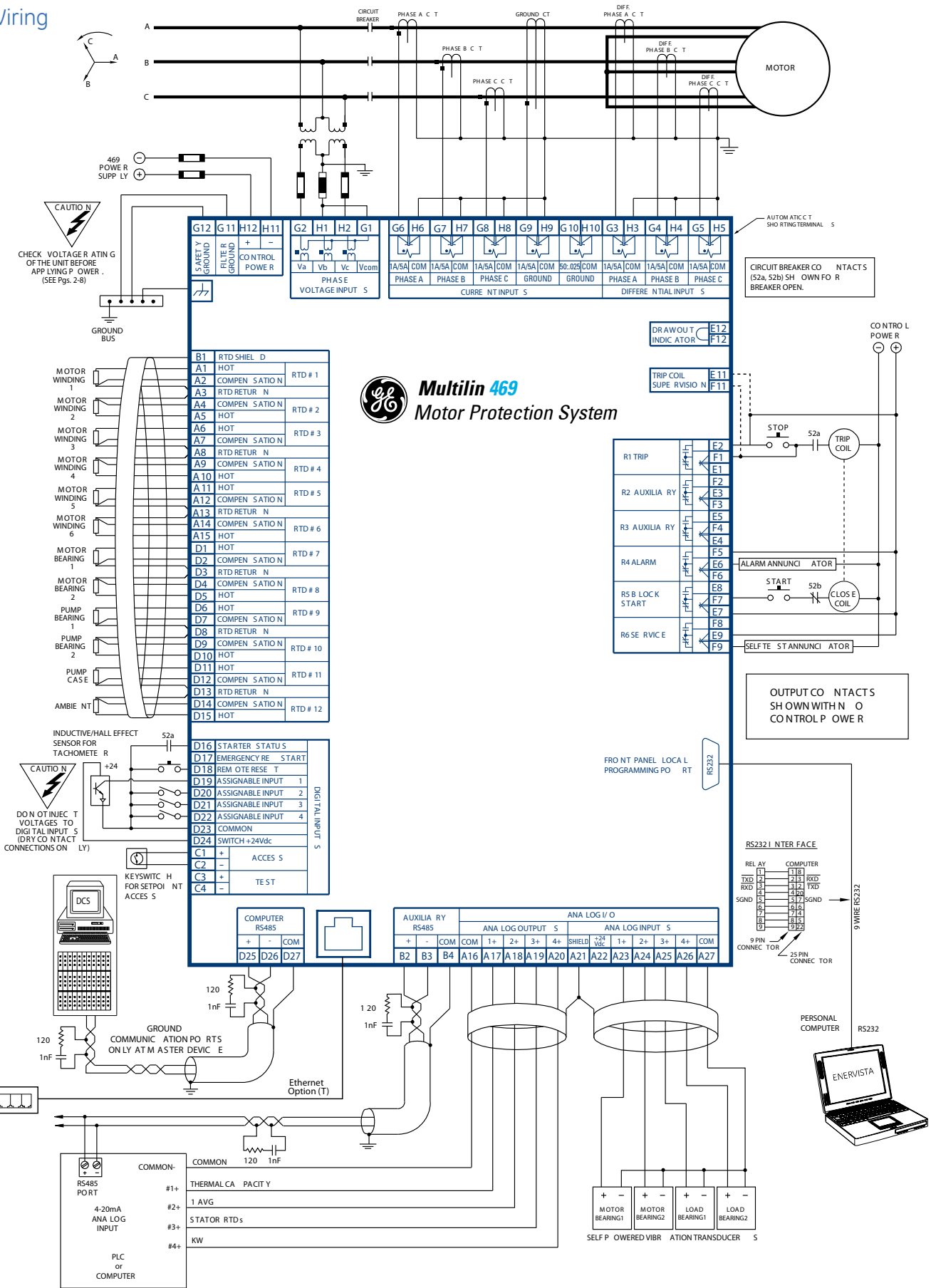

GE Multilin 469
Motor Protection System

OUTPUT CONTACTS SHOWN WITH NO CONTROL POWER

RS232 INTERFACE

REL AY	F1	F1B
TXD	2	2B
RXD	3	3B
TXD	4	4B
RXD	5	5B
SGND	6	6B
SGND	7	7B
SGND	8	8B
SGND	9	9B
SGND	10	10B
SGND	11	11B
SGND	12	12B

9 PIN CONNECTOR
25 PIN CONNECTOR



Technical Specifications

PROTECTION		PROTECTION		INPUTS			
PHASE SHORT CIRCUIT		OVERVOLTAGE		PHASE CURRENT INPUTS			
Pickup Level:	2.0 to 20.0 x CT primary in steps of 0.1 of any one phase	Pickup Level:	1.01 to 1.10 x rated in steps of 0.01 any one phase	CT Primary:	1 to 5000 A		
Time Delay:	0 to 1000 ms in steps of 10	Time Delay:	0.1 to 60.0 s in steps of 0.1	CT Secondary:	1 A or 5 A (must be specified with order)		
Pickup Accuracy:	as per Phase Current Inputs	Pickup Accuracy:	as per Voltage Inputs	Burden:	Less than 0.2 VA at rated load		
Timing Accuracy:	+50 ms	Timing Accuracy:	±100 ms or ±0.5% of total time	Conversion Range:	0.05 to 20 x CT		
Elements:	Trip	Elements:	Trip and Alarm	Nominal Frequency:	20 - 70 Hz		
REDUCED VOLTAGE START		VOLTAGE PHASE REVERSAL		Frequency Range:	20 - 120 Hz		
Transition Level:	25 to 300% FLA in steps of 1	Configuration:	ABC or ACB phase rotation	Accuracy:	at < 2 x CT: ±0.5% of 2 x CT at > 2 x CT: ±1% of 20 x CT		
Transition Time:	1 to 250 s in steps of 1	Timing Accuracy:	500 to 700 ms	CT Withstand:	1 second at 80 x rated current 2 seconds at 40 x rated current continuous at 3 x rated current		
Transition Control:	Current, Timer, Current and Timer	Elements:	Trip	DIFFERENTIAL CURRENT INPUTS			
OVERLOAD/STALL PROTECTION/THERMAL MODEL		FREQUENCY		CT Primary:	1 to 5000 A		
Overload Curves:	15 Standard Overload Curves, Custom Curve, Voltage Dependent Custom Curve for high inertia starting (all curves time out against average phase current)	Required Voltage:	> 30% of full scale in Phase A	CT Secondary:	1 A or 5 A (Set point)		
Curve Biasing	Phase Unbalance	Overfrequency Pkp:	25.01 to 70.00 in steps of 0.01	Burden:	Less than 0.2 VA at rated load		
	Hot/Cold Curve Ratio	Accuracy:	±0.02 Hz	Conversion Range:	0.02 to 1 x CT primary Amps		
	Stator RTD	Time Delay:	0.1 to 60.0 s in steps of 0.1	Nominal Frequency:	20 - 70 Hz		
	Running Cool Rate	Timing Accuracy:	<100 ms or ±0.5% of total time	Frequency Range:	20 - 120 Hz		
	Stopped Cool Rate	Elements:	Trip and Alarm	Accuracy:	±0.5% of 1 x CT for 5 A ±0.5% of 5 x CT for 1 A		
Line Voltage	Overload Pickup:	1.01 to 1.25 (for service factor)	DIGITAL INPUTS		CT Withstand:	1 second at 80 x rated current 2 seconds at 40 x rated current continuous at 3 x rated current	
Overload Pickup:	Pickup Accuracy:	as per Phase Current Inputs	REMOTE SWITCH		GROUND CURRENT INPUTS		
Pickup Accuracy:	Timing Accuracy:	±100 ms or ±2% of total time	Configurable:	Assignable to Digital Inputs 1 to 4	CT Primary:	1 to 5000 A	
Elements:	Elements:	Trip and Alarm	Timing Accuracy:	100 ms max.	CT Secondary:	1 A or 5 A (Set point)	
MECHANICAL JAM		SPEED SWITCH		Elements:	Trip and Alarm	Burden:	< 0.2 VA at rated load for 1 A or 5 A < 0.25 VA for 50:025 at 25 A
Pickup Level:	1.01 to 3.00 x FLA in steps of 0.01 of any one phase, blocked on start	Configurable:	Assignable to Digital Inputs 1 to 4	Conversion Range:	0.02 to 1 x CT primary Amps	Nominal Frequency:	20 - 70 Hz
Time Delay:	1 to 30 s in steps of 1	Time Delay:	1.0 to 250.0 s in steps of 0.1	Frequency Range:	20 - 120 Hz	Accuracy:	±0.5% of 1 x CT for 5 A ±0.5% of 5 x CT for 1 A ±0.125 A for 50:025
Pickup Accuracy:	as per Phase Current Inputs	Timing Accuracy:	100 ms max.	CT Withstand:	1 second at 80 x rated current 2 seconds at 40 x rated current continuous at 3 x rated current	VOLTAGE INPUTS	
Timing Accuracy:	±0.5 s or ±0.5% of total time	Elements:	Trip	LOAD SHED		VT Ratio:	1.00 to 150.00:1 in steps of 0.01
Elements:	Trip	PRESSURE SWITCH		Configurable:	Assignable to Digital Inputs 1 to 4	VT Secondary:	273 V AC (full scale)
UNDERCURRENT		Configurable:	Assignable to Digital Inputs 1 to 4	Time Delay:	0.1 to 100.0 s in steps of 0.1	Conversion Range:	0.05 to 1.00 x full scale
Pickup Level:	0.01 - 0.99 x CT Trip 0.01 - 0.95 x CT Alarm in steps of 0.01	Time Delay:	0 to 5000 s in steps of 1	Block From Start:	0 to 5000 s in steps of 1	Nominal Frequency:	20 - 70 Hz
Time Delay:	1 to 60 s in steps of 1	Timing Accuracy:	±100 ms or ±0.5% of total time	Elements:	Trip and Alarm	Frequency Range:	20 - 120 Hz
Block From Start:	0 to 15000 s in steps of 1	Elements:	Trip and Alarm	VIBRATION SWITCH		Accuracy:	±0.5% of full scale
Pickup Accuracy:	as per Phase Current Inputs	DIGITAL COUNTER		Configurable:	Assignable to Digital Inputs 1 to 4	Max. Continuous:	280 V AC
Timing Accuracy:	±0.5 s or ±0.5% of total time	Configurable:	Assignable to Digital Inputs 1 to 4	Count Frequency:	<50 times a second	Burden:	> 500 k Ω
Elements:	Trip and Alarm	Range:	0 to 1 000 000 000	Elements:	Alarm	DIGITAL INPUTS	
CURRENT UNBALANCE		TACHOMETER		Inputs:	9 opto-isolated inputs	469 Sensor Supply:	
Unbalance:	I ₂ / I ₁ if I _{avg} > FLA I ₂ / I ₁ x I _{avg} / FLA if I _{avg} < FLA	Configurable:	Assignable to Digital Inputs 1 to 4	External Switch:	dry contact < 400 Ω , or open collector NPN transistor from sensor; 6 mA sinking from internal 4 K Ω pull-up at 24 V DC with V _{ce} < 4 V DC	+24 V DC at 20 mA maximum	
Range:	0 to 100% UB in steps of 1	RPM Range:	100 to 7200 RPM	RTD INPUTS		RTD INPUTS	
Pickup Level:	4 to 40% UB in steps of 1	Pulse Duty Cycle:	> 10%	3 wire RTD Types:		100 Ω Platinum (DIN.43760), 100 Ω Nickel, 120 Ω Nickel, 10 Ω Copper	5 mA
Time Delay:	1 to 60 s in steps of 1	Elements:	Trip and Alarm	RTD Sensing		Current:	
Pickup Accuracy:	±2%	GENERAL PURPOSE		Isolation:		36 Vpk (isolated with analog inputs and outputs)	
Timing Accuracy:	±0.5 s or ±0.5% of total time	Configurable:	Assignable Digital Inputs 1 to 4	Range:		-50 to +250°C	
Elements:	Trip and Alarm	Time Delay:	0.1 to 5000.0 s in steps of 0.1	Accuracy:		±2°C	
PHASE DIFFERENTIAL		Block From Start:	0 to 5000 s in steps of 1	Lead Resistance:		25 Ω Max per lead for Pt and Ni type 3 Ω Max per lead for Cu type	
Pickup Level:	0.05 to 1.0 x CT primary in steps of 0.01 of any one phase	Timing Accuracy:	±100 ms or ±0.5% of total time	No Sensor:		>1000 Ω	
Time Delay:	0 to 1000 ms in steps of 10	Elements:	Trip and Alarm	Short/Low Alarm:		< -50°C	
Pickup Accuracy:	as per Phase Differential Current Inputs	ACCELERATION TIMER		TRIP COIL SUPERVISION		Applicable Voltage:	
Timing Accuracy:	+50 ms	Pickup:	Transition of no phase current to > overload pickup	Trickle Current:		2 to 5 mA	
Elements:	Trip	Dropout:	When current falls below overload pickup	ANALOG CURRENT INPUTS		Current Inputs:	
GROUND INSTANTANEOUS		Time Delay:	1.0 to 250.0 s in steps of 0.1	Input Impedance:		0 to 1 mA, 0 to 20 mA or 4 to 20 mA (setpoint)	
Pickup Level:	0.1 to 1.0 x CT primary in steps of 0.01	Timing Accuracy:	±100 ms or ±0.5% of total time	Conversion Range:		226 Ω ±10%	
Time Delay:	0 to 1000 ms in steps of 10	Elements:	Trip	Accuracy:		0 to 21 mA	
Pickup Accuracy:	as per Ground Current Input	JOGGING BLOCK		Type:		±1% of full scale	
Timing Accuracy:	+50 ms	Starts/Hour:	1 to 5 in steps of 1	Analog In Supply:		passive	
Elements:	Trip and Alarm	Time between Starts:	1 to 500 min.	Response Time:		+24 V DC at 100 mA maximum	
RESTART BLOCK		Timing Accuracy:	±0.5 s or ±0.5% of total time			100 ms	
Time Delay:	1 to 50000 s in steps of 1	Elements:	Block				
Timing Accuracy:	±0.5 s or ±0.5% of total time	RTD					
Elements:	Block	Pickup:	1 to 250°C in steps of 1				
UNDERVOLTAGE		Pickup Hysteresis:	2°C				
Pickup Level:	0.60 to 0.99 x Rated in steps of 0.01	Time Delay:	3 s				
Motor Starting:	0.60 to 0.99 x Rated in steps of 0.01 any one phase	Elements:	Trip and Alarm				
Motor Running:	0.60 to 0.99 x Rated in steps of 0.01 any one phase	UNDERVOLTAGE					
Time Delay:	0.1 to 60.0 s in steps of 0.1	Pickup Level:	0.60 to 0.99 x Rated in steps of 0.01				
Pickup Accuracy:	as per Voltage Inputs	Motor Starting:	0.60 to 0.99 x Rated in steps of 0.01 any one phase				
Timing Accuracy:	<100 ms or ±0.5% of total time	Motor Running:	0.60 to 0.99 x Rated in steps of 0.01 any one phase				
Elements:	Trip and Alarm	Time Delay:	0.1 to 60.0 s in steps of 0.1				
		Pickup Accuracy:	as per Voltage Inputs				
		Timing Accuracy:	<100 ms or ±0.5% of total time				
		Elements:	Trip and Alarm				

Please refer to Multilin 469 Motor Protection System Instruction Manual for complete technical specifications

Technical Specifications (continued)

OUTPUTS

ANALOG OUTPUTS

Type: Active
Range: 4 to 20 mA, 0 to 1 mA (must be specified with order)
Accuracy: ±1% of full scale
Maximum Load: 4 to 20 mA input: 1200 Ω, 0 to 1 mA input: 10 kΩ
Isolation: 36 Vpk (Isolation with RTDs and Analog Inputs)
4 Assignable Outputs: phase A current, phase B current, phase C current, 3 phase average current, ground current, phase AN (AB) voltage, phase BN (BC) voltage, phase CN (CA) voltage, 3 phase average voltage, hottest stator RTD, hottest bearing RTD, hottest other RTD, RTD # 1 to 12, Power factor, 3-phase Real power (kW), 3-phase Apparent power (kVA), 3-phase Reactive power (kvar), Thermal Capacity Used, Relay Lockout Time, Current Demand, kvar Demand, kW Demand, kVA Demand, Motor Load, Torque Motor Load, Torque

OUTPUT RELAYS

Configuration: 6 Electromechanical Form C
Contact: silver alloy
Material:
Operate Time: 10 ms
Max ratings for 100000 operations

VOLTAGE		M/C CONT.	M/C 0.2 SEC.	BREAK	MAX LOAD
DC Resistive	30 VDC	10 A	30 A	10 A	300 W
	125 VDC	10 A	30 A	0.5 A	62.5 W
	250 VDC	10 A	30 A	0.3 A	75 W
DC Inductive L/R = 40 ms	30 VDC	10 A	30 A	5 A	150 W
	125 VDC	10 A	30 A	0.25 A	31.3 W
AC Resistive	120 VAC	10 A	30 A	10 A	2770 VA
	250 VAC	10 A	30 A	10 A	2770 VA
AC Inductive P.F. = 0.4	120 VAC	10 A	30 A	4 A	480 VA
	250 VAC	10 A	30 A	3 A	750 VA

POWER SUPPLY

CONTROL POWER

Options: LO / HI (must be specified with order)
LO Range: DC: 20 to 60 V DC AC: 20 to 48 V AC at 48 to 62 Hz
Hi Range: DC: 90 to 300 V DC AC: 70 to 265 V AC at 48 to 62 Hz
Power: 45 VA (max), 25 VA typical
 Proper operation time without supply voltage: 30 ms

COMMUNICATIONS

RS232 Port: 1, Front Panel, non-isolated
RS485 Ports: 2, Isolated together at 36 Vpk
Baud Rates: RS485: 300 - 19,200 Baud programmable parity RS232: 9600
Parity: None, Odd, Even
Protocol: Modbus® RTU / half duplex
Ethernet Port: 10BaseT, RJ45 Connector, ModBus® RTU over TCP/IP

MONITORING

POWER FACTOR

Range: 0.01 lead or lag to 1.00
Pickup Level: 0.99 to 0.05 in steps of 0.01, Lead & Lag
Time Delay: 0.2 to 30.0 s in steps of 0.1
Block From Start: 0 to 5000 s in steps of 1
Pickup Accuracy: ±0.02
Timing Accuracy: ±100 ms or ±0.5% of total time
Elements: Trip and Alarm

3-PHASE REAL POWER

Range: 0 to ±99999 kW
Underpower Pkp: 1 to 25000 kW in steps of 1
Time Delay: 1 to 30 s in steps of 1
Block From Start: 0 to 15000 s in steps of 1
Pickup Accuracy: at $avg < 2 \times CT$: ±1% of $\sqrt{3} \times 2 \times CT \times VT$ full scale at $avg > 2 \times CT \pm 1.5\%$ of $3 \times 20 \times CT \times VT \times VT$ full scale
Timing Accuracy: ±0.5 s or ±0.5% of total time
Elements: Trip and Alarm

3-PHASE APPARENT POWER

Range: 0 to 65535 kVA at $avg < 2 \times CT$: ±1% of $\sqrt{3} \times 2 \times CT \times VT \times VT$ full scale at $avg > 2 \times CT \pm 1.5\%$ of $3 \times 20 \times CT \times VT \times VT$ full scale

3-PHASE REACTIVE POWER

Range: 0 to ±99999 kW
Pickup Level: ±1 to 25000 kW in steps of 1
Time Delay: 0.2 to 30.0 s in steps of 1
Block From Start: 0 to 5000 s in steps of 1
Pickup Accuracy: at $avg < 2 \times CT$: ±1% of $\sqrt{3} \times 2 \times CT \times VT \times VT$ full scale at $avg > 2 \times CT \pm 1.5\%$ of $3 \times 20 \times CT \times VT \times VT$ full scale
Timing Accuracy: ±100 ms or ±0.5% of total time
Elements: Trip and Alarm

OVERTORQUE

Pickup Level: 1.0 to 999999.9 Nm/ft-lb in steps of 0.1; torque unit is selectable under torque setup
Time Delay: 0.2 to 30.0 s in steps of 0.1
Pickup Accuracy: ±2.0%
Time Accuracy: ±100 ms or 0.5% of total time
Elements: Alarm (INDUCTION MOTORS ONLY)

METERED REAL ENERGY CONSUMPTION

Description: Continuous total real power consumption
Range: 0 to 999999.999 MW-hours.
Timing Accuracy: ±0.5%
Update Rate: 5 seconds

METERED REACTIVE ENERGY CONSUMPTION

Description: Continuous total reactive power consumption
Range: 0 to 999999.999 Mvar-hours
Timing Accuracy: ±0.5%
Update Rate: 5 seconds

METERED REACTIVE POWER GENERATION

Description: Continuous total reactive power generation
Range: 0 to 2000000.000 Mvar-hours
Timing Accuracy: ±0.5%
Update Rate: 5 seconds

PRODUCT TESTS

Thermal Cycling: Operational test at ambient, reducing to -40°C and then increasing to 60°C
Dielectric Strength: 2.0 kV for 1 minute from relays, CTs, VTs, power supply to Safety Ground

TYPE TESTS

Dielectric voltage withstand: EN60255-5
Impulse voltage withstand: EN60255-5
Damped Oscillatory Discharge: IEC 61000-4-18 / IEC 60255-22-1
Electrostatic Discharge: EN61000-4-2 / IEC 60255-22-2
RF immunity: EN61000-4-3 / IEC 60255-22-3
Fast Transient Disturbance: EN61000-4-4 / IEC 60255-22-4
Surge Immunity: EN61000-4-5 / IEC 60255-22-5
Conducted RF Immunity: EN61000-4-6 / IEC 60255-22-6
Radiated & Conducted Emissions: CISPR11 / CISPR22 / IEC 60255-25
Sinusoidal Vibration: IEC 60255-21-1
Voltage Dip & interruption: IEC 61000-4-11
Ingress Protection: IEC 60068-2-1
Environmental (Cold): IEC 60068-2-2
Environmental (Dry heat): IEC 60068-2-2
ESD: IEEE / ANSI/C37.90.3
Safety: UL508 / UL C22.2-14 / UL1053

CERTIFICATION

ISO: Manufactured under an ISO9001 registered system.
CE: EN60255-5 / EN60255-27 / EN61010-1 / EN50263
cULus: UL508 / UL1053 / C22.2.No 14

ENVIRONMENTAL

Temperature Range:
 Operating: -40 °C to +60 °C
 Ambient Storage: -40 °C to +80 °C
 Ambient Shipping: -40 °C to +80 °C
 Humidity: Operating up to 95% (non condensing) @ 55C
 Pollution degree: 2
 IP Rating: IP40 (front), IP20 (back)

DeviceNet CONFORMANCE TESTED™



Ordering

469	*	*	*	*	*	
469	P1	LO	A1	D		Basic Unit
	P5	HI	A20	E		1 A phase CT secondaries
				T		5 A phase CT secondaries
						DC: 24 - 60 V; AC: 20 - 48 V @ 48 -62 Hz control power
						DC: 90 - 300 V; AC: 70 - 265 V @ 48 -62 Hz control power
						0 - 1 mA analog outputs
						4 - 20 mA analog outputs
						DeviceNet
						Enhanced front panel
						Enhanced front panel with Ethernet 10BaseT option
						Harsh (Chemical) Environment Conformal Coating

GEGridSolutions.com

IEC is a registered trademark of Commission Electrotechnique Internationale. IEEE is a registered trademark of the Institute of Electrical Electronics Engineers, Inc. Modbus is a registered trademark of Schneider Automation. NERC is a registered trademark of North American Electric Reliability Council. NIST is a registered trademark of the National Institute of Standards and Technology.

GE, the GE monogram, Multilin, FlexLogic, EnerVista and CyberSentry are trademarks of General Electric Company.

GE reserves the right to make changes to specifications of products described at any time without notice and without obligation to notify any person of such changes.

Copyright 2017, General Electric Company. All Rights Reserved.



imagination at work

GEA-32037(E)
English
170711